

Comes with feet or flanges.

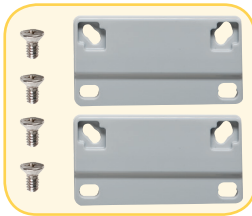

## PREMIUM POLYCARBONATE ENCLOSURE

### Features and Benefits

- Standard color – light gray with a gloss finish.
- Best material – bases, opaque covers and clear covers are all made of high-impact, UV resistant polycarbonate.
- Easy ordering – one part number includes base, lid, mounting feet or flanges and all lid fastening hardware (mounting panels sold separately).
- Flexible interior mounting – features the unique and patented Integra adjustable depth “T-Rail” back panel mounting system (back panel and adjustable brackets sold separately).
- Features multiple bosses for easy installation of devices and DIN rails.
- UL-50 / c-UL Listed (files # E229365, # E207562)

Our Premium Line enclosures are the most durable, non-metallic Nema UL rated enclosures available. From the extremely versatile mounting options inside the enclosure to having the most off-the-shelf accessories, the Integra “Made In the USA” Premium Line enclosures provide great value to any application.

Mechanical and Thermal	Test Spec.	Unit	Premium Line
Instrumented Dart Impact @ 73° F		in/lb.	565
Falling Ball Impact @ 73° F	UL-746	in/lb.	900
Deflection Temperature @ 264 psi	ASTM D648	Deg. F	270
Modulus of Elasticity	ASTM D790	ksi	340
Temperature Range		Deg. F	-40 to 265
Flammable / UV Ratings	Test Spec.	Unit	Premium Line
Flame Rating - UL	UL 94	-	5VA
Outdoor UV Exposure	UL	-	F1



Atex pending, contact factory for details

6064 P/N	4X IP66	6P IP68	Hinged Cover	Screw Cover	Opaque Cover	Clear Cover	Mounting Feet	Mounting Flange	Stainless Steel Locking Latch	Non-Metallic Locking Latch
H6064S	✓	✓		✓	✓		✓			
H6064SC	✓	✓		✓		✓	✓			
H6064SF	✓	✓		✓	✓			✓		
H6064SCF	✓	✓		✓		✓		✓		
H6064H	✓		✓	✓	✓		✓			
H6064HC	✓		✓	✓		✓	✓			
H6064HF	✓		✓	✓	✓			✓		
H6064HCF	✓		✓	✓		✓		✓		
H6064HLL	✓		✓		✓		✓		✓	
H6064HCLL	✓		✓			✓	✓		✓	
H6064HFLL	✓		✓		✓			✓	✓	
H6064HCFL	✓		✓			✓		✓	✓	
H6064HNL	✓		✓		✓		✓			✓
H6064HCNL	✓		✓			✓	✓			✓
H6064HFNL	✓		✓		✓			✓		✓
H6064HCFNL	✓		✓			✓		✓		✓
H6064H-6P	✓	✓	✓	✓	✓		✓			
H6064HC-6P	✓	✓	✓	✓		✓	✓			
H6064HF-6P	✓	✓	✓	✓	✓			✓		
H6064HCF-6P	✓	✓	✓	✓		✓		✓		

TORQUE SPECIFICATIONS - Mounting Brackets - 1/4"-20 x 0.25 SS, countersunk phillips drive screws (torque limit = 20 in. lbs.) | Covers / Doors - Torque for corner screws is 10 in. lbs.





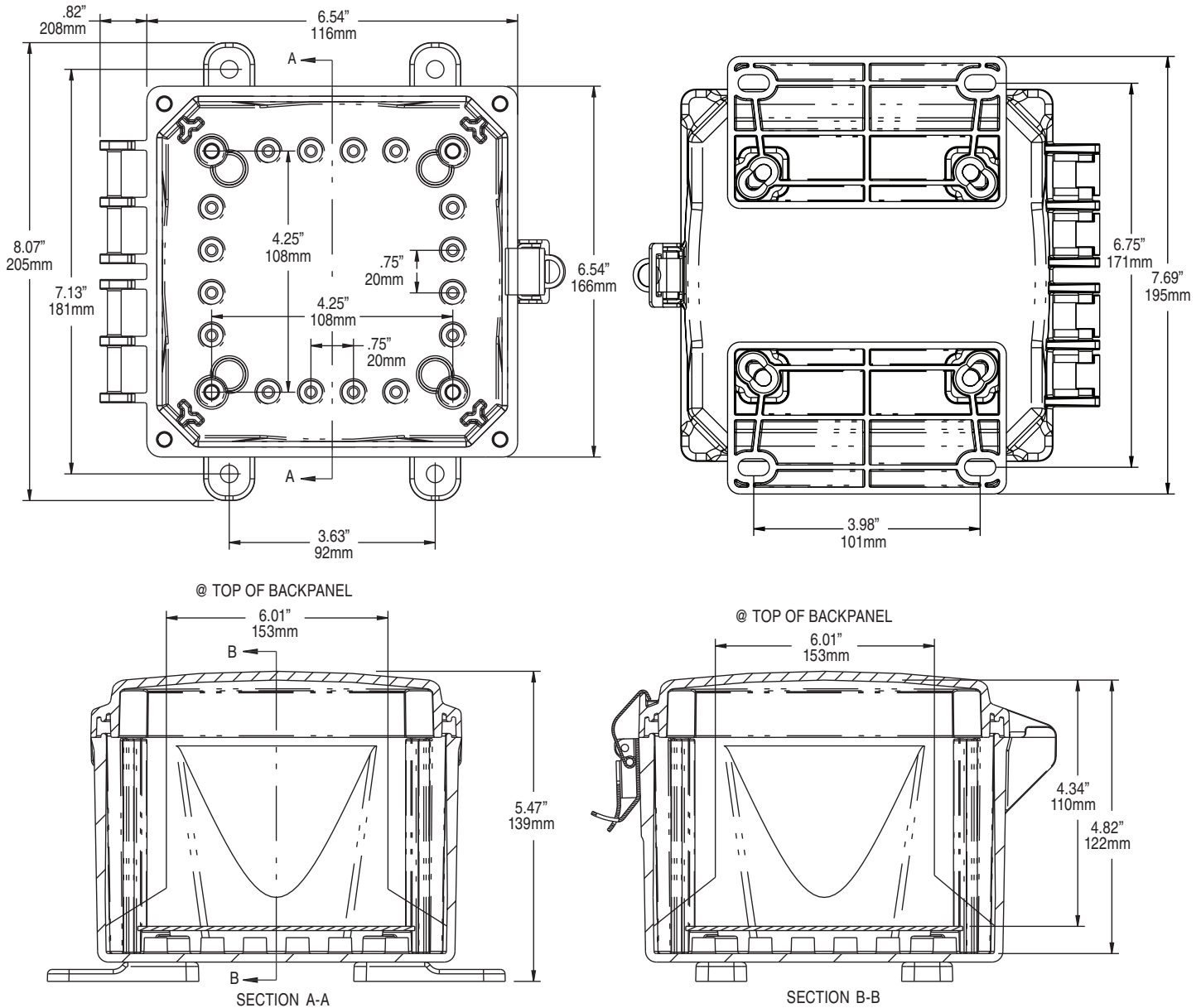





# 6X6X4 PREMIUM LINE

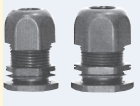

Register online to download this drawing off the Integra website at [www.integraenclosures.com](http://www.integraenclosures.com) | Your company's logo or other information on the lid. Consult factory for details.

## Accessories for 6x6x4 (For complete accessories, see page 49-52)

 <p><b>Back Panels</b>  <b>ABP66</b> - Aluminum panel  <b>SBP66</b> - Steel panel  <b>PVCBP66</b> - PVC panel</p>	 <p><b>Aluminum Swing Out Panels</b>  <b>ABP-66USP/USOPK</b> - Complete panel kit  <b>ABP-66USP</b> - Aluminum swing out panels only  <b>USOPK</b> - Hardware only</p>	 <p><b>Back Panel Adjustment Kit</b>  <b>BPAKG</b> - Gray, Set Screw  <b>BPAKB</b> - Black, Set Screw  <b>UBPAKG</b> - Gray, Thumb Screw  <b>UBPAKB</b> - Black Thumb Screw</p>
 <p><b>Air Vents</b>  <b>VENT 3</b> - Aluminum louvered  <b>VENT 2</b> - Outdoor labyrinth</p>	 <p><b>Steel Swing Out Panels</b>  <b>SBP-66USP/USOPK</b> - Complete panel kit  <b>SBP-66USP</b> - Steel swing out panels only  <b>USOPK</b> - Hardware only</p>	 <p><b>Cord Grips</b>  IP68/NEMA 4X/6P rated  See page 53 for more details and part numbers.</p>
 <p><b>Din Rail</b>  <b>DIN 6</b> - 2 rails, 4 screws</p>	 <p><b>Pole Mounting Kit</b>  <b>PMKG-26</b> - 2" pole  <b>PMKG-36</b> - 3" pole  <b>PMKG-46</b> - 4" pole  <b>PMKG-126</b> - 12" pole</p>	 <p><b>Mounting Feet &amp; Flange Kits</b>  <b>MFKG</b> - Premium line feet  <b>MFKSS</b> - Stainless steel feet  <b>MFLK6</b> - 6" Flange kit</p>